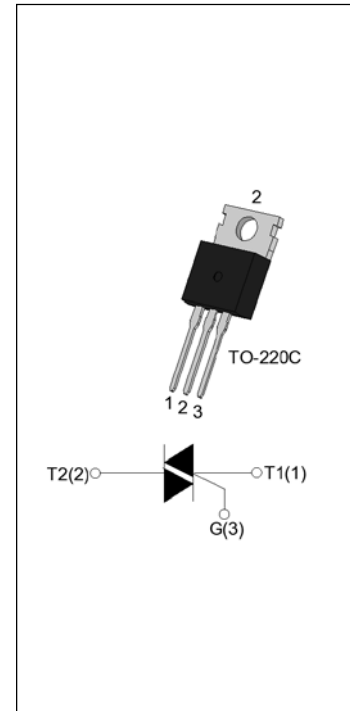

**JST10C-800BW 10A TRIAC**

Rev.A.1.1

**DESCRIPTION:**

The JST10C-800BW triac is suitable for general purpose AC switching. It can be used as an ON/OFF function in applications such as heating regulation, induction motor starting circuits, for phase control operation in light dimmers, motor speed controllers. JST10C-800BW snubberless triac is especially recommended for use on inductive loads. From T2 terminals to external heatsink. Package TO-220C is RoHS compliant.

**MAIN FEATURES**

Symbol	Value	Unit
$I_{T(RMS)}$	10	A
$V_{DRM}/V_{RRM}$	800	V
$I_{GT\ I/II/III}$	50/50/50	mA

**ABSOLUTE MAXIMUM RATINGS**

Parameter	Symbol	Value	Unit
Storage junction temperature range	$T_{stg}$	-40-150	°C
Operating junction temperature range	$T_j$	-40-125	°C
Repetitive peak off-state voltage ( $T_j=25^\circ\text{C}$ )	$V_{DRM}$	800	V
Repetitive peak reverse voltage ( $T_j=25^\circ\text{C}$ )	$V_{RRM}$	800	V
RMS on-state current ( $T_c \leq 106^\circ\text{C}$ )	$I_{T(RMS)}$	10	A
Non repetitive surge peak on-state current (full cycle , $t_p=20\text{ms}$ , $T_j=25^\circ\text{C}$ )	$I_{TSM}$	100	A
Non repetitive surge peak on-state current (full cycle , $t_p=16.6\text{ms}$ , $T_j=25^\circ\text{C}$ )		110	
$I^2t$ value for fusing ( $t_p=10\text{ms}$ , $T_j=25^\circ\text{C}$ )	$I^2t$	50	$\text{A}^2\text{s}$
Critical rate of rise of on-state current ( $I_G=2 \times I_{GT}$ , $f=100\text{Hz}$ , $T_j=125^\circ\text{C}$ )	$di/dt$	100	$\text{A}/\mu\text{s}$
Peak gate current ( $t_p=20\mu\text{s}$ , $T_j=125^\circ\text{C}$ )	$I_{GM}$	4	A
Average gate power dissipation ( $T_j=125^\circ\text{C}$ )	$P_{G(AV)}$	0.5	W
Peak gate power	$P_{GM}$	10	W

Peak pulse voltage ( $T_j=25^{\circ}\text{C}$ ; non-repetitive, off-state; FIG.7)	$V_{pp}$	4.5	kV
--	----------	-----	----

**ELECTRICAL CHARACTERISTICS** ( $T_j=25^{\circ}\text{C}$  unless otherwise specified)

Symbol	Test Condition	Quadrant	Value		Unit
$I_{GT}$	$V_D=12\text{V}$ $R_L=33\Omega$	I - II -III	MAX.	50	mA
$V_{GT}$		I - II -III	MAX.	1	V
$V_{GD}$	$V_D=V_{DRM}$ $T_j=125^{\circ}\text{C}$ $R_L=3.3\text{k}\Omega$	I - II -III	MIN.	0.2	V
$I_L$	$I_G=1.2I_{GT}$	I -III	MAX.	70	mA
		II		90	
$I_H$	$I_T=500\text{mA}$		MAX.	60	mA
dV/dt	$V_D=540\text{V}$ Gate Open $T_j=125^{\circ}\text{C}$		MIN.	1500	V/ $\mu\text{s}$
(dI/dt)c	(dV/dt)c=20V/ $\mu\text{s}$ $T_j=125^{\circ}\text{C}$		MIN.	15	A/ms
$t_{on}$	$I_G=80\text{mA}$ $I_A=400\text{mA}$ $I_R=40\text{mA}$ $T_j=25^{\circ}\text{C}$		TYP.	5	$\mu\text{s}$
$t_{off}$				50	

**STATIC CHARACTERISTICS**

Symbol	Parameter		Value(MAX.)	Unit
$V_{TM}$	$I_{TM}=16\text{A}$ $t_p=380\mu\text{s}$	$T_j=25^{\circ}\text{C}$	1.5	V
$V_{TO}$	Threshold voltage	$T_j=125^{\circ}\text{C}$	0.77	V
$R_D$	Dynamic resistance	$T_j=125^{\circ}\text{C}$	35	m $\Omega$
$I_{DRM}$	$V_D=V_{DRM}$ $V_R=V_{RRM}$	$T_j=25^{\circ}\text{C}$	5	$\mu\text{A}$
$I_{RRM}$		$T_j=125^{\circ}\text{C}$	0.4	mA

**THERMAL RESISTANCES**

Symbol	Parameter	Value	Unit
$R_{th(j-c)}$	junction to case (AC)	1.4	$^{\circ}\text{C/W}$
$R_{th(j-a)}$	junction to ambient (AC)	60	$^{\circ}\text{C/W}$

ORDERING INFORMATION

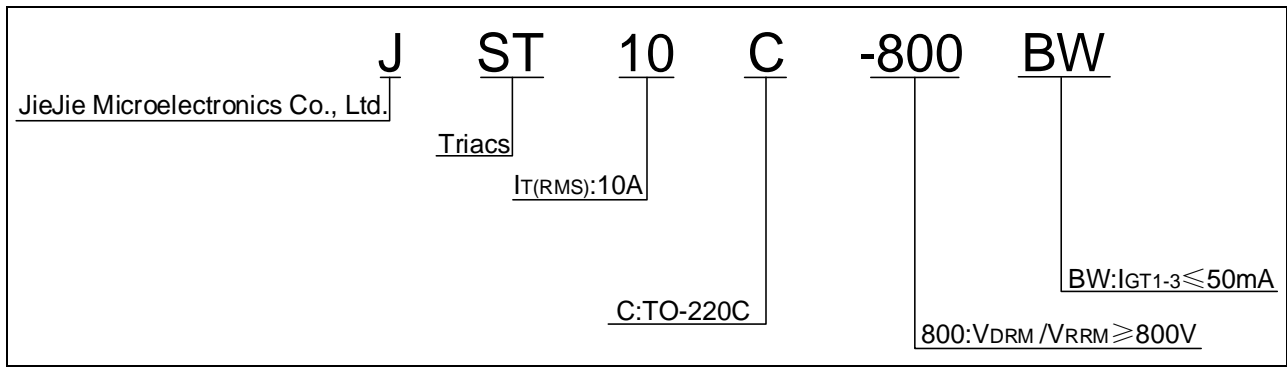

MARKING

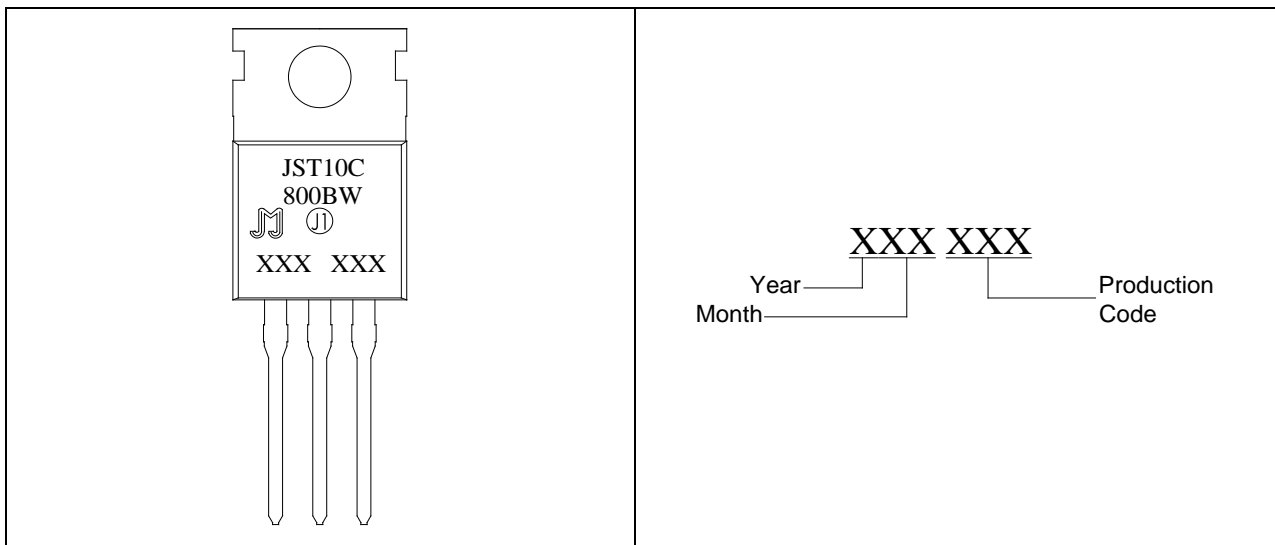

**FIG.1:** Maximum power dissipation versus RMS on-state current

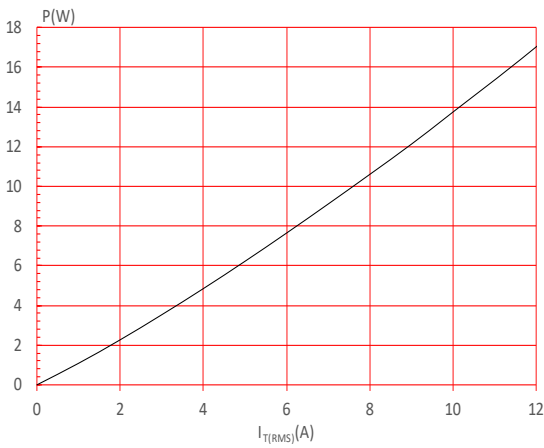

**FIG.2:** RMS on-state current versus case temperature

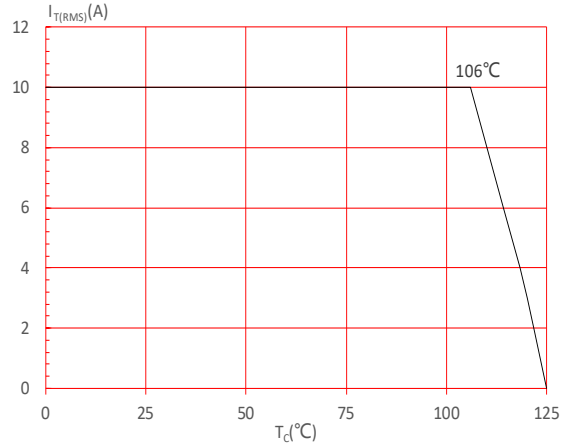

**FIG.3:** Surge peak on-state current versus number of cycles

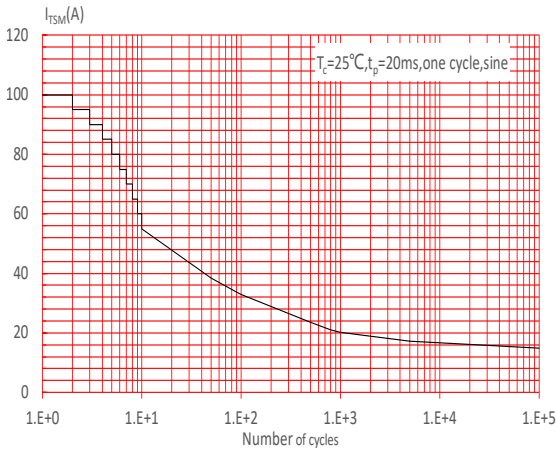

**FIG.4:** On-state characteristics

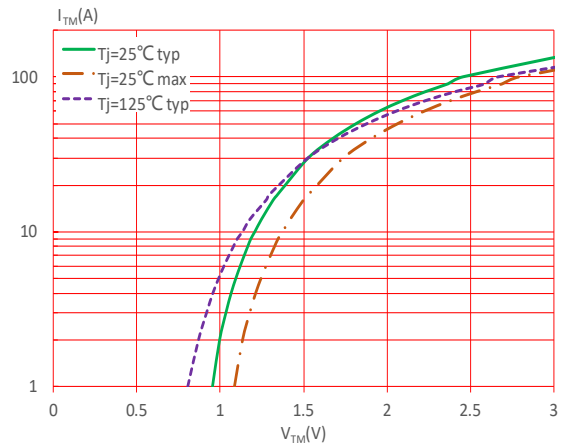

**FIG.5:** Non-repetitive surge peak on-state current for a sinusoidal pulse with width  $t_p < 20\text{ms}$ , and corresponding value of  $I^2t$  ( $di/dt < 100\text{A}/\mu\text{s}$ )

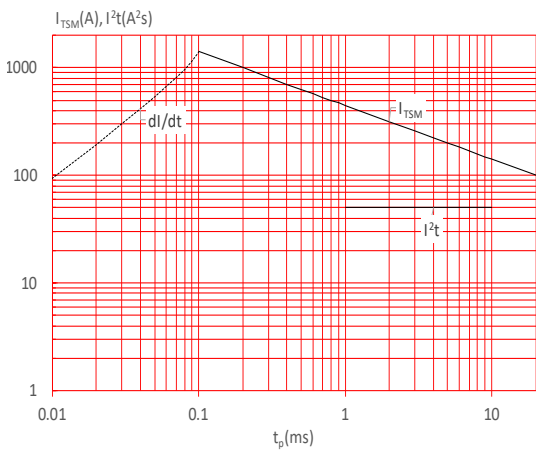

**FIG.6:** Relative variations of gate trigger current, holding current and latching current versus junction temperature

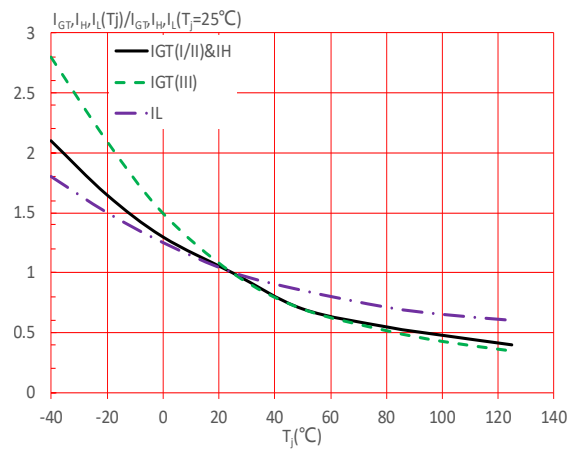
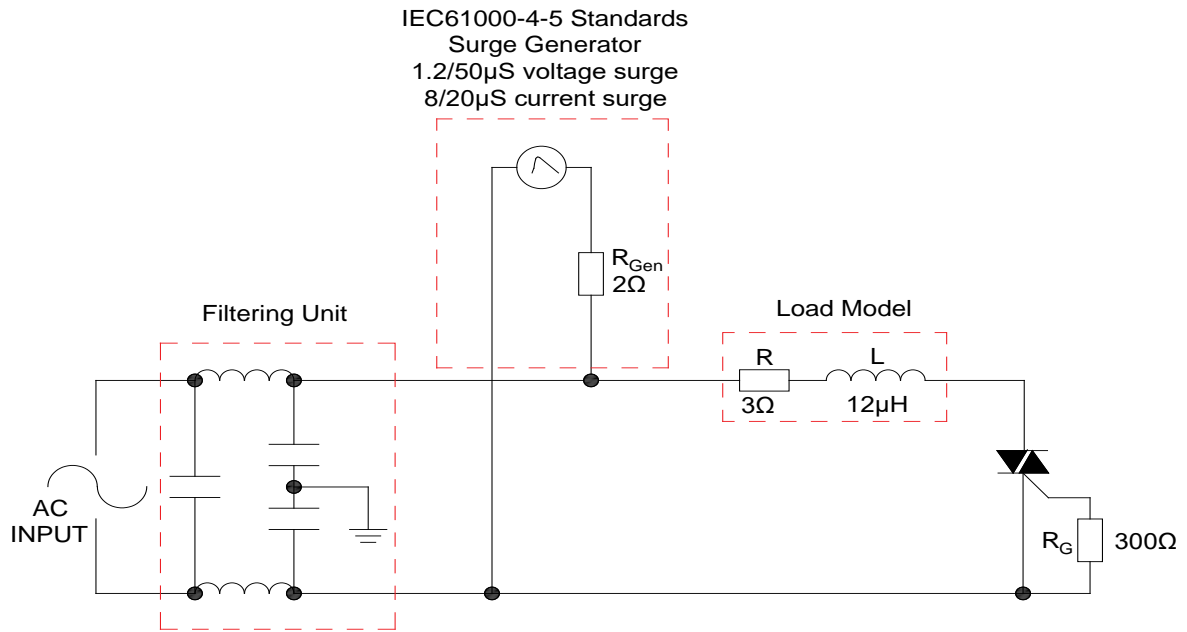

FIG.7: Test circuit for inductive and resistive loads to IEC-61000-4-5 standards



## LEAD FORMING AND SOLDERING

Refer to the application note “Assembly Instructions for Thyristors in Through-hole Package” released by JieJie Microelectronics

**ORDERING INFORMATION**

Order code	Voltage $V_{DRM}/V_{RRM}$ (V)	IGT(mA)	Package	Base qty. (pcs)	Delivery mode
		I - II - III			
JST10C-800BW	800	50	TO-220C	50	Tube

**Document Revision History**

Date	Revision	Changes
Apr.11, 2023	A.1.0	Last updated
Oct.15, 2025	A.1.1	Revise PACKAGE MECHANICAL DATA

PACKAGE MECHANICAL DATA

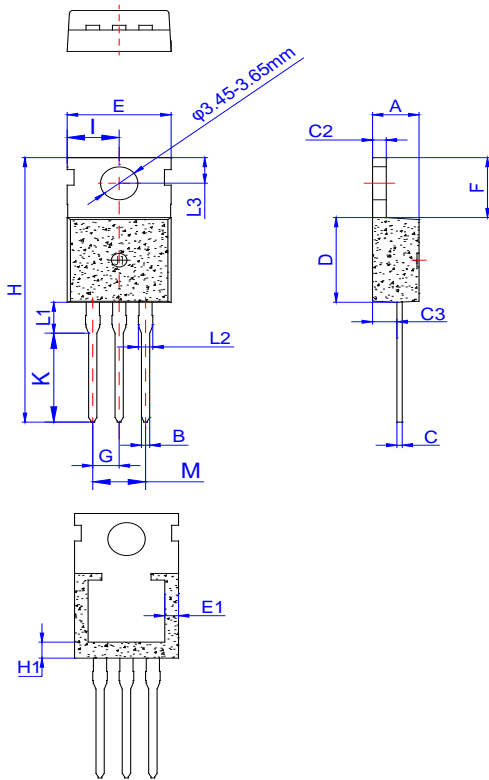

Ref.	Dimensions					
	Millimeters			Inches		
	Min.	Typ.	Max.	Min.	Typ.	Max.
A	4.40		4.60	0.173		0.181
B	0.70		0.90	0.028		0.035
C	0.45		0.60	0.018		0.024
C2	1.25		1.35	0.049		0.053
C3	2.20		2.60	0.087		0.102
D	8.90		9.90	0.350		0.390
E	9.90		10.30	0.390		0.406
E1	0.80		1.20	0.031		0.047
F	6.30		6.90	0.248		0.272
G	2.40		2.70	0.094		0.106
H	28.00		29.80	1.102		1.173
H1	2.15		2.55	0.085		0.100
I	4.70		5.10	0.185		0.201
K	9.90		10.30	0.390		0.406
L1	2.70		3.30	0.106		0.130
L2	1.14		1.70	0.045		0.067
L3	2.65		2.95	0.104		0.116
M	4.80		5.20	0.189		0.205

DELIVERY MODE

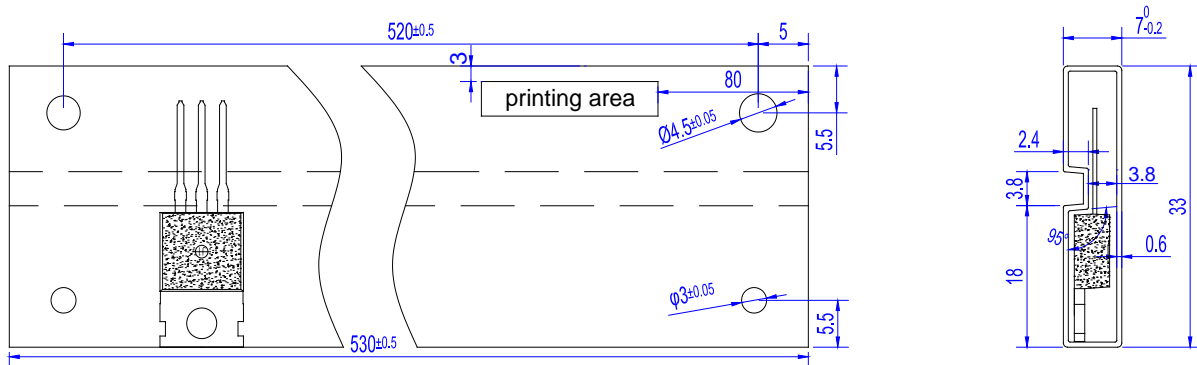

PACKAGE	OUTLINE	TUBE (PCS)	INNER BOX (PCS)	PER CARTON
TO-220C	TUBE	50	1,000	5,000

Information furnished in this document is believed to be accurate and reliable. However, Jiangsu JieJie Microelectronics Co., Ltd. assumes no responsibility for the consequences of use without consideration for such information nor use beyond it. Information mentioned in this document is subject to change without notice, apart from that when an agreement is signed, Jiangsu JieJie complies with the agreement.

Products and information provided in this document have no infringement of patents. Jiangsu JieJie assumes no responsibility for any infringement of other rights of third parties which may result from the use of such products and information. This document supersedes and replaces all information previously supplied.



is a registered trademark of Jiangsu JieJie Microelectronics Co., Ltd.

Copyright © 2025 Jiangsu JieJie Microelectronics Co., Ltd. All rights reserved.