

### DESCRIPTION:

The products are transistor opto-couplers in a SSOP4 package. The device is a photoelectric coupler composed of light-emitting diode and phototransistor. The products are widely used in switching power supply, intelligent meter, industrial control, measuring instruments, office equipment such as copiers, household appliances: such as air conditioners, fans, water heaters, etc.

### MAIN FEATURES

- High isolation 3750 VRMS
- Operating temperature range -40°C to 125°C
- RoHS & REACH Compliance
- HBM: H3A; MM: M4; CDM:C3
- CQC approved
- VDE approved
- UL approved

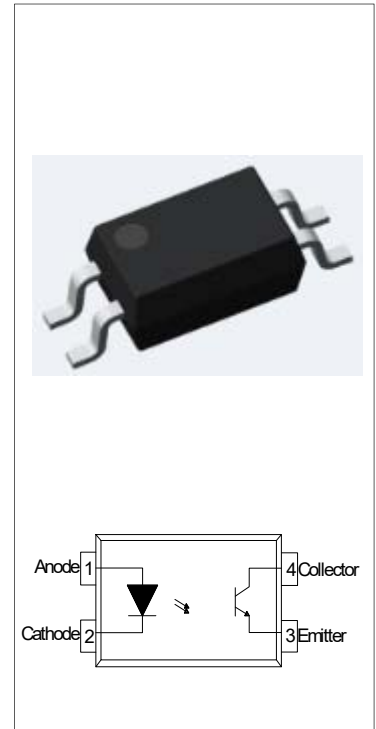

### ABSOLUTE MAXIMUM RATINGS (Temperature=25°C)

Parameter		Symbol	Value	Unit
Input	Forward Current	$I_F$	50	mA
	Peak Forward Current	$I_{FP}$	1 <sup>①</sup>	A
	Reverse Voltage	$V_R$	6	V
	Power Dissipation	$P_D$	75	mW
Output	Collector-emitter Voltage	$V_{CEO}$	80	V
	Emitter-collector Voltage	$V_{ECO}$	7	V
	Collector Current	$I_C$	50	mA
	Power Dissipation	$P_C$	150	mW
Total Power Dissipation		$P_{tot}$	225	mW
Isolation Voltage		$V_{iso}$	3750 <sup>②</sup>	Vrms
Operating Temperature		$T_{opr}$	-40~+125	°C
Junction Temperature		$T_j$	135	°C
Storage Temperature		$T_{stg}$	-55~+125	°C
Soldering Temperature		$T_{sol}$	260	°C

**NOTE1:** 1  $\mu$ s pulse      **NOTE2:** AC for 1minute, R.H.=40~60%

**ELECTRICAL CHARACTERISTICS** (Temperature=25°C)

Parameter		Symbol	Condition	Min.	Typ.	Max.	Unit
Input	Forward Voltage	$V_F$	$I_F=10\text{mA}$	-	1.2	1.5	V
	Reverse Current	$I_R$	$V_R=6\text{V}$	-	-	1	$\mu\text{A}$
	Terminal Capacitance	$C_t$	$V=0,$ $f=1\text{MHz}$	-	30	250	pF
Output	Collector-Emitter dark current	$I_{CEO}$	$V_{CE}=20\text{V},$ $I_F=0$	-	-	50	nA
	Collector-Emitter breakdown voltage	$BV_{CEO}$	$I_C=0.1\text{mA}$ $I_F=0$	80	-	-	V
	Emitter-Collector breakdown voltage	$BV_{ECO}$	$I_E=0.1\text{mA}$ $I_F=0$	7	-	-	V
Transfer Characteristics	Current transfer ratio	CTR <sup>①</sup>	$I_F=5\text{mA}$ $V_{CE}=5\text{V}$	100	-	400	%
	Collector-Emitter Saturation Voltage	$V_{CE(sat)}$	$I_F=10\text{mA}$ $I_C=1\text{mA}$	-	0.07	0.2	V
	Isolation resistance	$R_{IO}$	DC500V 40~60%R.H.	$5 \times 10^{10}$	$10^{11}$	-	$\Omega$
	Floating Capacitance	$C_{IO}$	$V=0,$ $f=1\text{MHz}$	-	0.3	1	pF
	Cut-off Frequency	$f_c$	$V_{CE}=5\text{V},$ $I_C=2\text{mA}$ $R_L=100\Omega,$ -3dB	-	80	-	kHz
	Rise Time	$t_r$	$V_{CE}=2\text{V},$ $I_C=2\text{mA}$ $R_L=100\Omega$	-	4	18	$\mu\text{s}$
	Fall Time	$t_f$		-	3	18	$\mu\text{s}$
	Response Time	$t_{on}$		-	9	25	$\mu\text{s}$
$t_{off}$		-		5	25	$\mu\text{s}$	

**NOTE1:** Rank Table of Current Transfer Ratio (Temperature=25°C)

CTR Rank	Min. (%)	Max. (%)	Test Condition
P	200	400	$I_F=0.5\text{mA}, V_{CE}=5\text{V}$
	200	400	$I_F=5\text{mA}, V_{CE}=5\text{V}$
Q	100	300	$I_F=0.5\text{mA}, V_{CE}=5\text{V}$
	100	300	$I_F=5\text{mA}, V_{CE}=5\text{V}$

**ORDERING INFORMATION**

<p><b>J</b></p> <p>JieJie Microelectronics Co., Ltd.</p>	<p><b>OC</b></p> <p>Opto Coupler</p>	<p><b>T</b></p> <p>Transistor</p>	<p><b>217</b></p> <p>Marketization Model</p>	<p><b>P</b></p> <p>CTR Rank:P/Q</p>	<p><b>t</b></p> <p>t:High Temperature</p>	<p><b>-S4</b></p> <p>SSOP4</p>	<p><b>/</b></p> <p>None:T1 R:T2</p>
--	--------------------------------------	-----------------------------------	--	-------------------------------------	---	--------------------------------	---

Packing Quantity	
Option	Quantity
None/R	3000 Units/Reel

**MARKING**

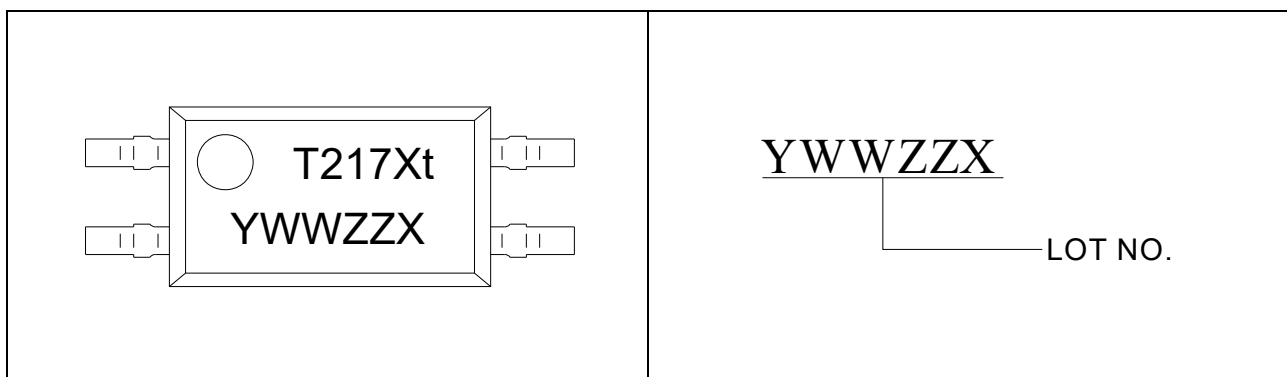

Characteristics Curves

FIG.1: Max. Allowable LED Forward Current vs. Ambient Temperature

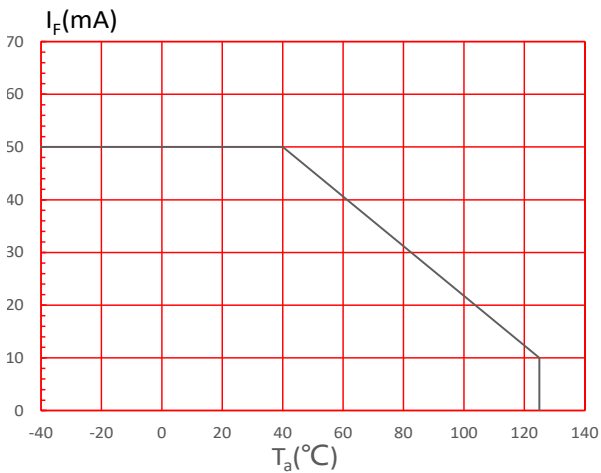

FIG.2: Collector Power Dissipation vs. Ambient Temperature

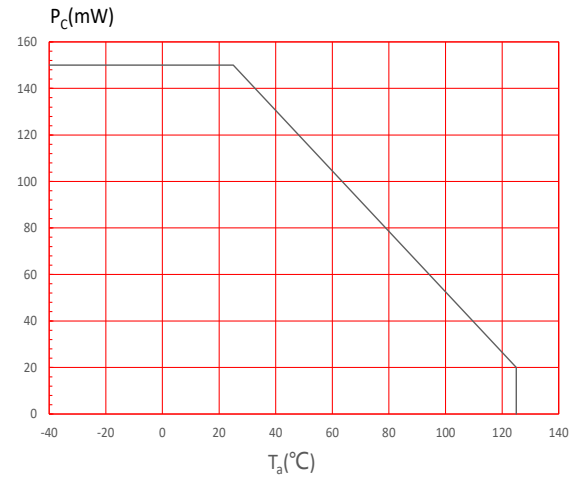

FIG.3: Forward Current vs. Forward Voltage

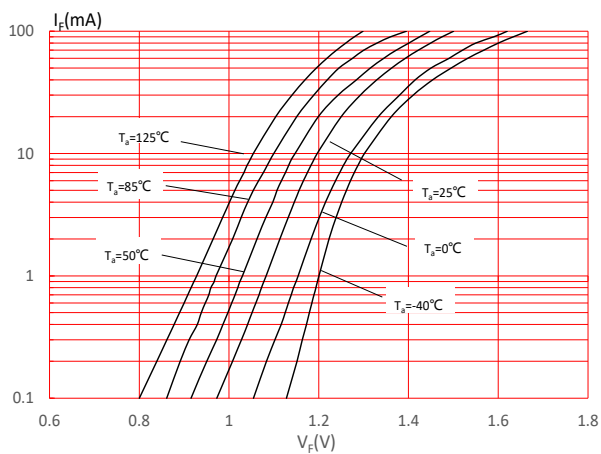

FIG.4: Normalized Collector Dark Current vs. Ambient Temperature

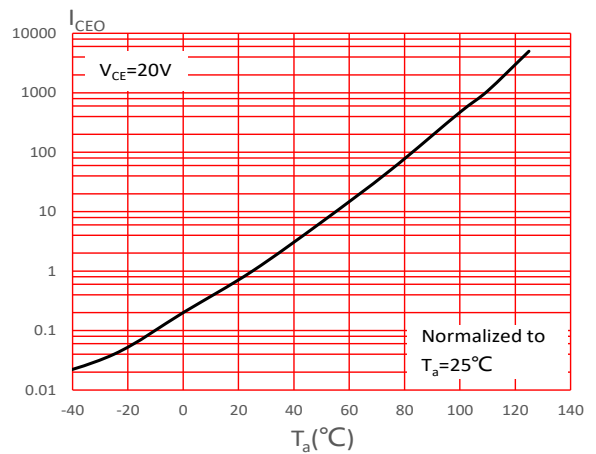

FIG.5: Collector Current vs. Collector-emitter Voltage

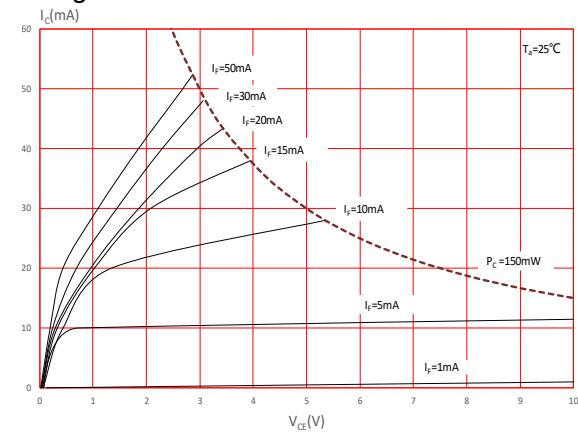

FIG.6: Normalized Current Transfer Ratio vs. Forward Current

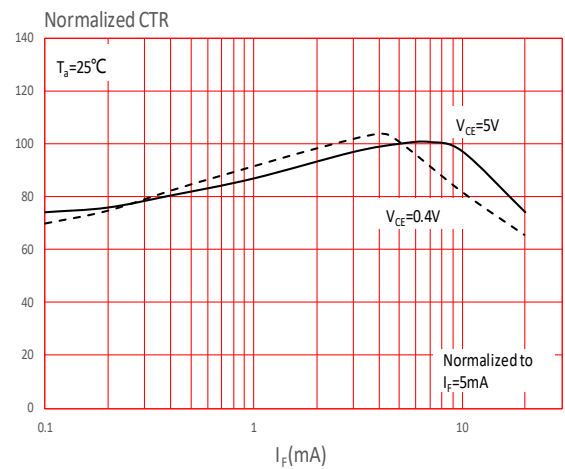

FIG.7: Normalized Current Transfer Ratio vs. Ambient Temperature

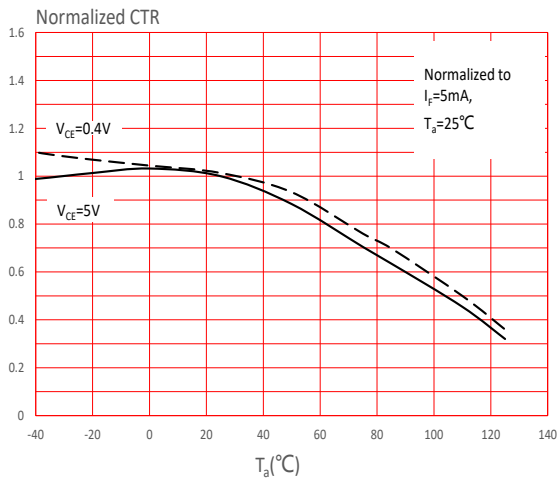

FIG.8: Normalized Collector-emitter Saturation Voltage vs. Ambient Temperature

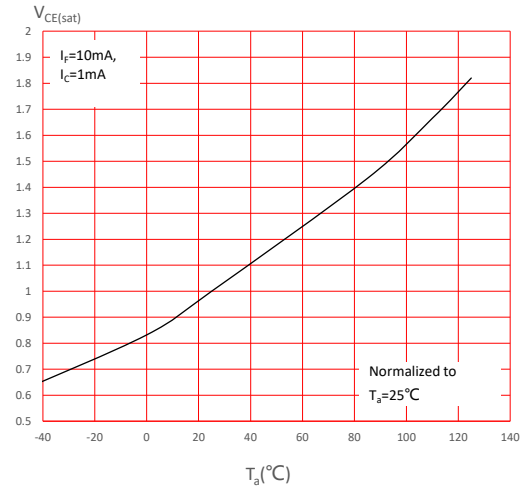

FIG.9: Response Time vs. Load Resistance

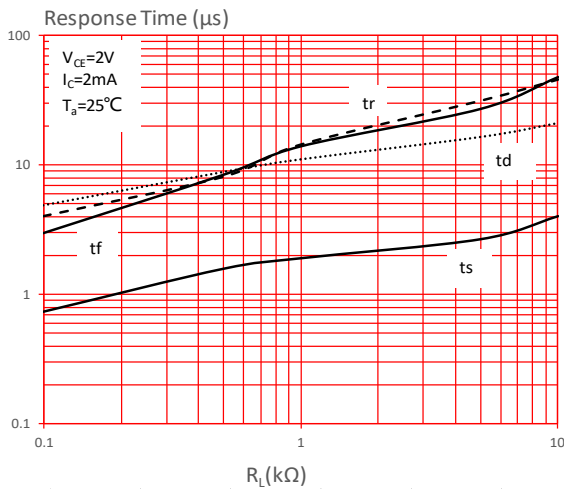
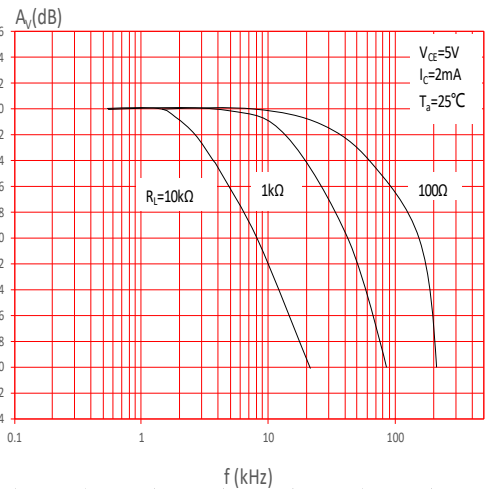

FIG.10: Frequency Response



Test Circuits

FIG.11: Test Circuits of Response Time

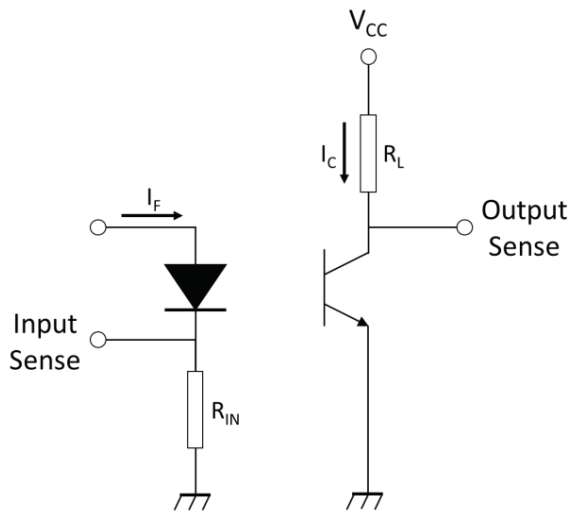

FIG.12: Curves of Response Time

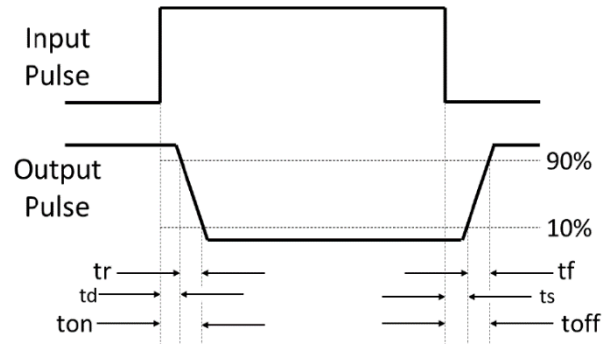
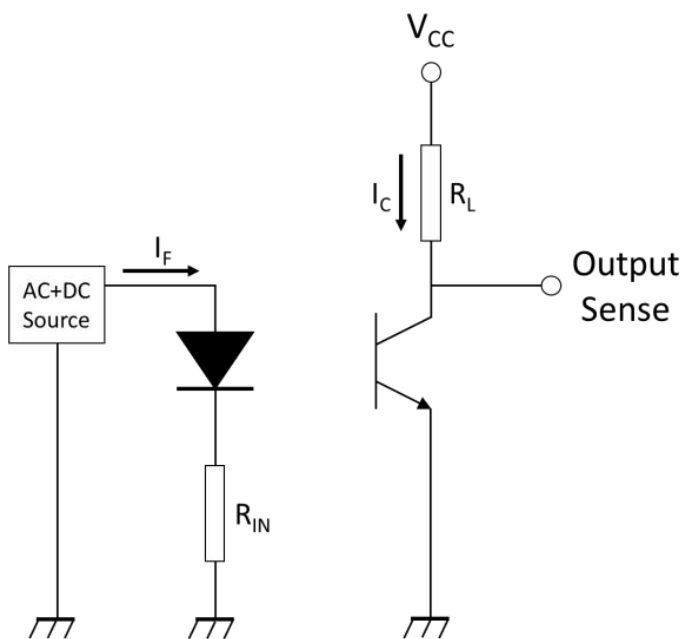
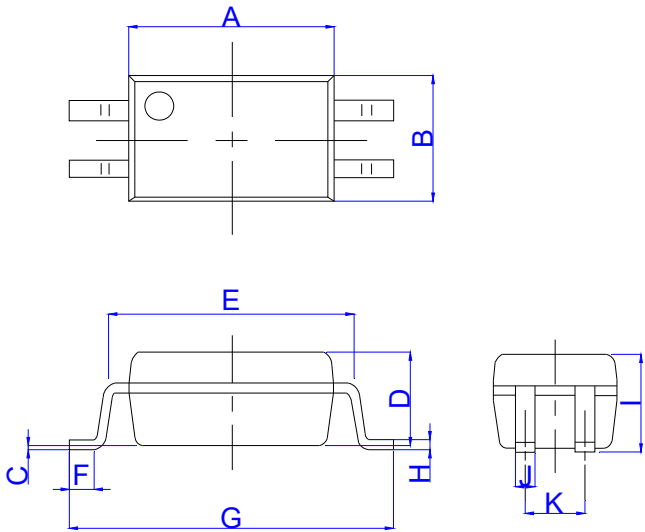

FIG.13: Test Circuits of Frequency Response



Package Dimension (Unit: mm)



Ref.	Dimensions					
	Millimeters			Inches		
	Min.	Typ.	Max.	Min.	Typ.	Max.
A	4.40		4.80	0.173		0.189
B	2.40		2.80	0.094		0.110
C	0.00		0.20	0.000		0.008
D	1.98		2.18	0.078		0.086
E	5.00		5.60	0.197		0.220
F	0.39		0.89	0.015		0.035
G	6.70		7.30	0.264		0.287
H	0.10		0.30	0.004		0.012
I	1.88		2.48	0.074		0.098
J	0.30		0.50	0.012		0.020
K	1.02		1.52	0.040		0.060

RECOMMENDED SOLDER MASK (Dimensions in mm unless otherwise stated)

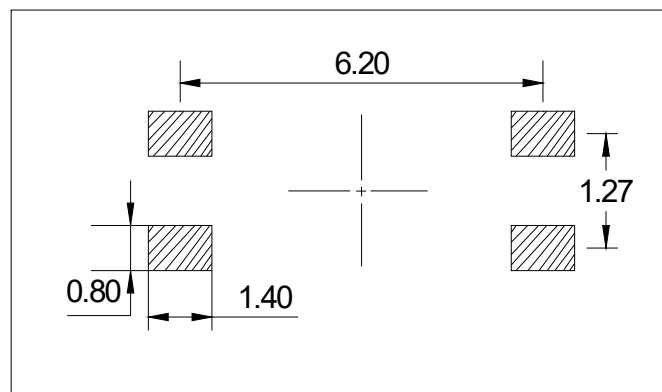

CARRIER TAPE SPECIFICATIONS (Dimensions in mm unless otherwise stated)

Option None/R

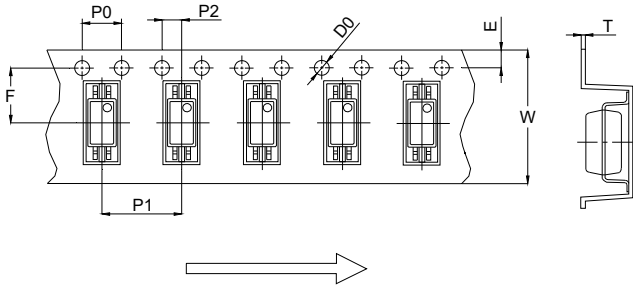

Ref.	Dimensions					
	Millimeters			Inches		
	Min.	Typ.	Max.	Min.	Typ.	Max.
D0		1.50	1.60		0.059	0.063
P0	3.90	4.00	4.10	0.154	0.157	0.161
P1	7.90	8.00	8.10	0.311	0.315	0.319
P2	1.90	2.00	2.10	0.075	0.079	0.083
E	1.65	1.75	1.85	0.065	0.069	0.073
F	5.40	5.50	5.60	0.213	0.217	0.220
T	0.20	0.25	0.30	0.008	0.010	0.012
W	11.90	12.10	12.30	0.469	0.476	0.484

REFLOW INFORMATION

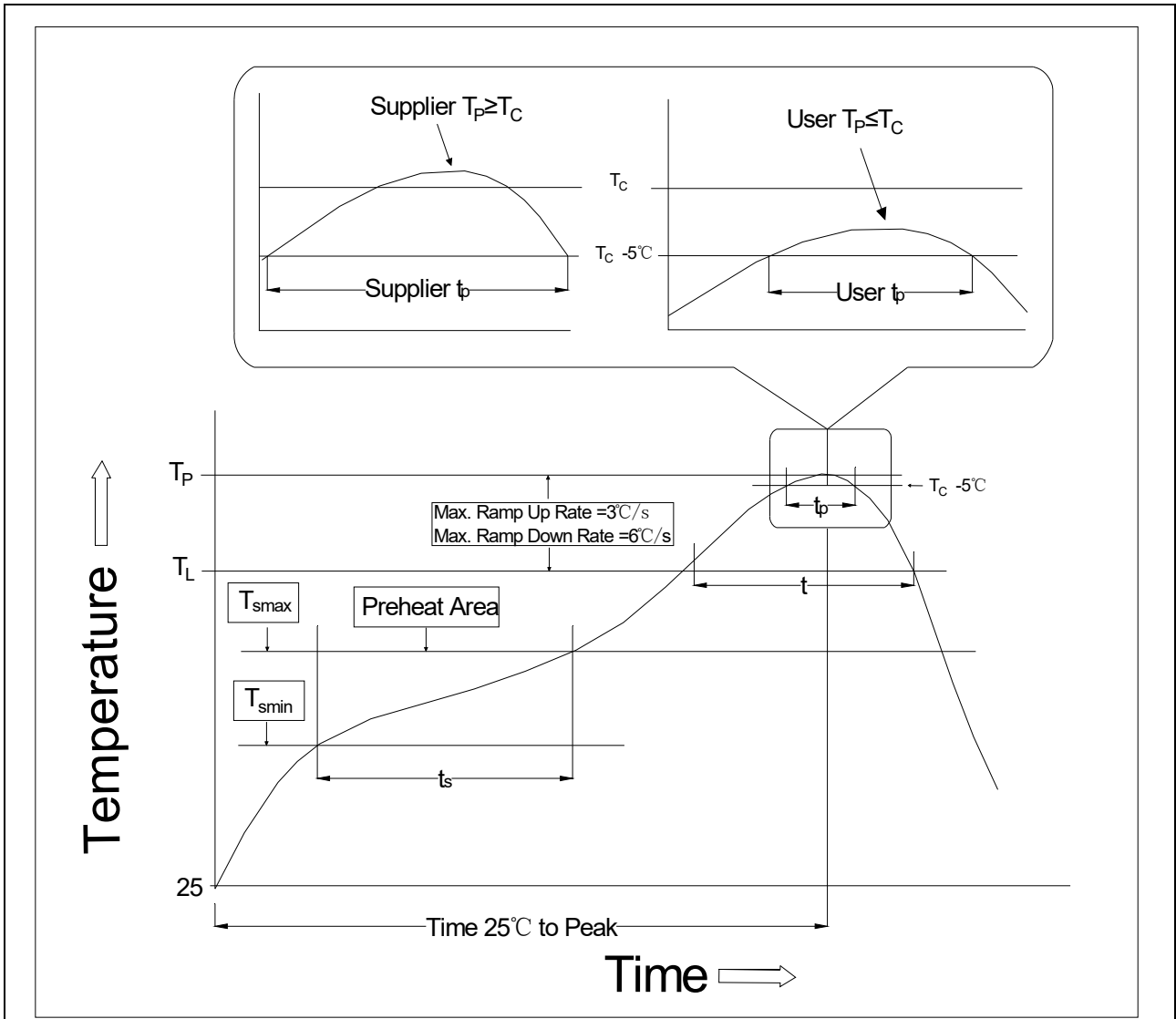

Profile Feature	Sn-Pb Assembly Profile	Pb-Free Assembly Profile
Temperature Min. (T <sub>smin</sub> )	100	150°C
Temperature Max. (T <sub>smax</sub> )	150	200°C
Time (t <sub>s</sub> ) from (T <sub>smin</sub> to T <sub>smax</sub> )	60-120 seconds	60-120 seconds
Ramp-up Rate (t <sub>L</sub> to t <sub>P</sub> )	3°C/second max.	3°C/second max.
Liquidus Temperature (T <sub>L</sub> )	183°C	217°C
Time (t <sub>L</sub> ) Maintained Above (T <sub>L</sub> )	60-150 seconds	60-150 seconds
Peak Body Package Temperature	235°C+0°C/-5°C	260°C+0°C/-5°C
Time (t <sub>P</sub> ) within 5°C of 260°C	20 seconds	30 seconds
Ramp-down Rate (T <sub>P</sub> to T <sub>L</sub> )	6°C/second max.	6°C/second max.
Time 25°C to Peak Temperature	6 minutes max.	8 minutes max.

Note:

1. Reflow soldering is recommended at the temperatures and times shown, no more than three times.
2. Avoid direct contact between the epoxy body and any tools or surfaces exceeding its maximum storage temperature.
3. Application of pressure on the epoxy body is prohibited at elevated temperatures. In specific scenarios, any applied force must not exceed 2.5N.
4. Ensure the component has cooled to ambient temperature before proceeding with any subsequent manufacturing steps.
5. The component has a shelf life of one year when stored under standard conditions.
6. Recommend storage Temp.: 0~40°C;  
Recommend storage humidity: <60%;  
MSL level: MSL 1

Information furnished in this document is believed to be accurate and reliable. However, Jiangsu JieJie Microelectronics Co., Ltd. assumes no responsibility for the consequences of use without consideration for such information nor use beyond it. Information mentioned in this document is subject to change without notice, apart from that when an agreement is signed, Jiangsu JieJie complies with the agreement.

Products and information provided in this document have no infringement of patents. Jiangsu JieJie assumes no responsibility for any infringement of other rights of third parties which may result from the use of such products and information. This document supersedes and replaces all information previously supplied.

 is a registered trademark of Jiangsu JieJie Microelectronics Co., Ltd.

Copyright © 2026 Jiangsu JieJie Microelectronics Co., Ltd. All rights reserved.