

JOC307XM4 Series

Rev.A.1.0

DESCRIPTION:

The JOC307XM4 series combine an AlGaAs infrared emitting diode as the emitter which is optically coupled to a monolithic silicon random-phase photo triac in a plastic SOP4 package. With the robust coplanar double mold structure, JOC307XM4 series provide the most stable isolation feature. The products are widely used in solenoid/value controls, lighting controls, motor controls, temperature controls, static AC power switches, solid state relays, interfacing microprocessors up to 265 V_{AC} peripherals.

MAIN FEATURES

- High isolation 3750 VRMS
- DC input with random-phase photo triac output
- Operating temperature range -55 °C to 100 °C
- REACH & RoHS compliance
- Halogen free
- MSL class 1
- HBM: H3A ; MM: M4
- CQC approved
- VDE approved
- UL approved

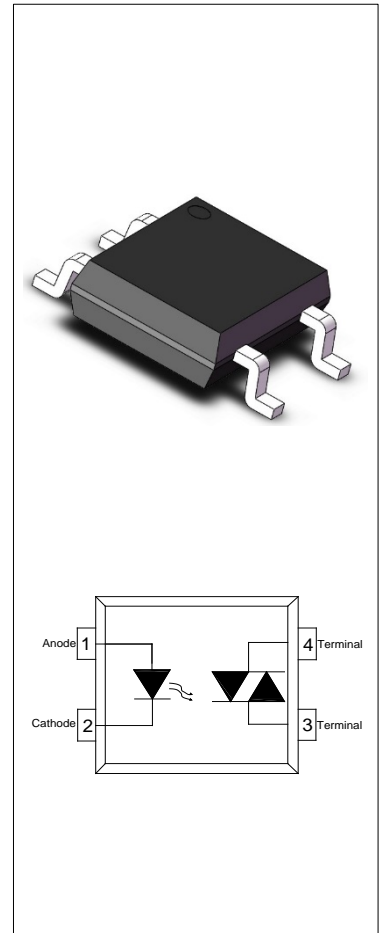

ABSOLUTE MAXIMUM RATINGS (Temperature=25°C)

Parameter		Symbol	Value	Unit
Input	Forward Current	I _F	60	mA
	Reverse Voltage	V _R	6	V
	Junction Temperature	T _j	125	°C
	Input Power Dissipation	P _I	100	mW
	Power Dissipation Derating (T _a ≥ 25°C)	Δ P _D /°C	-1.33	mW/°C
Output	Off-state Output Terminal Voltage	V _{OFF}	800	V
	Peak On-state Current (100μs pulse, 120 pps)	I _{TP}	2	A
	On-state RMS Current	I _{T(RMS)}	100	mA
	Peak Repetitive Surge Current (P _W =10 ms)	I _{TSM}	1	A

	Junction Temperature	T_j	125	°C
	Output Power Dissipation	P_o	250	mW
	Power Dissipation Derating ($T_a \geq 25^\circ\text{C}$)	$\Delta P_D/^\circ\text{C}$	-3.33	mW/°C
Total Power Dissipation		P_{tot}	350	mW
Isolation Voltage		V_{iso}	3750 ^①	V _{rms}
Operating Temperature		T_{opr}	-55~100	°C
Storage Temperature		T_{stg}	-55~125	°C
Soldering Temperature		T_{sol}	260 ^②	°C

NOTE1: AC for 1minute, R.H.=40~60%

NOTE2: For 10 seconds

ELECTRICAL CHARACTERISTICS (Temperature=25°C)

Parameter		Symbol	Condition	Min.	Typ.	Max.	Unit	
Input	Forward Voltage	V_F	$I_F=10\text{mA}$	-	1.2	1.4	V	
	Reverse Current	I_R	$V_R=6\text{V}$	-	-	1	μA	
	Input Capacitance	C_{in}	$V=0, f=1\text{kHz}$	-	14	-	pF	
Output	Peak Off-state Current, Either Direction	I_{OFF}	$V_{OFF}=800\text{V}, I_F=0$	-	-	100 ^③	nA	
	Peak On-state Voltage, Either Direction	V_{TM}	$I_{TM}=100\text{mA}$	-	2	2.5	V	
	Critical Rate of Rise of Off-state voltage	dV/dt	$V_{PEAK}=800\text{V}, I_F=0$	1000 ^④	-	-	V/μs	
Transfer Characteristics	LED Trigger Current	JOC3071M4	Terminal Voltage=3V $I_{TM}=100\text{mA}$	-	-	15	mA	
		JOC3072M4		-	-	10		
		JOC3073M4		-	-	5		
	Holding Current		I_H	$I_{TM}=2\text{mA}, I_F=\text{Rated } I_{FT}$	-	250	-	μA
	Isolation Resistance		R_{ISO}	DC500V 40~60%R.H.	10^{12}	10^{14}	-	Ω
	Floating Capacitance		C_{IO}	$V=0, f=1\text{MHz}$	-	0.4	-	pF
	Response Time		t_{on}	$V_D=6\text{V}, R_L=100\Omega, I_F=20\text{mA}$	-	15	50	μs

NOTE3: Test voltage must be applied within dV/dt ratings.

NOTE4: Refer to Fig.14 & Fig.15

ORDERING AND MARKING INFORMATION

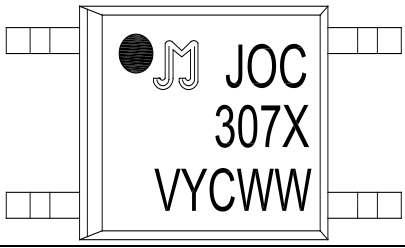
MARKING INFORMATION			
		JOC : Company Abbr. 307X : Part Number & Rank VYCWW : LOT NO.	
ORDERING INFORMATION			
JOC307XM(XZ)-GV			
JOC – Company Abbr. 307X – Rank (1/2/3) MX– SOP Package Z – Tape and Reel Option (T1/T2) G – Green V – VDE Option (V or None)			
Packing Quantity			
Option	Quantity	Quantity – Inner box	Quantity –Outer box
T1/T2	3000 Units/Reel	4 Reels/Inner box	5 Inner box/Outer box =60k Units

Characteristics Curves

FIG.1: Forward Current vs. Ambient Temperature

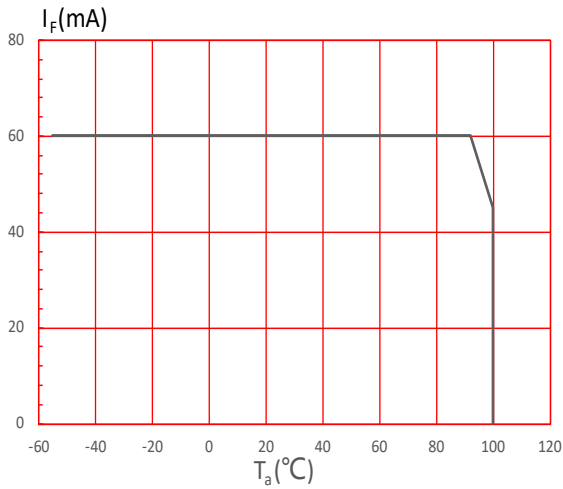

FIG.2: On-state Terminal Current vs. Ambient Temperature

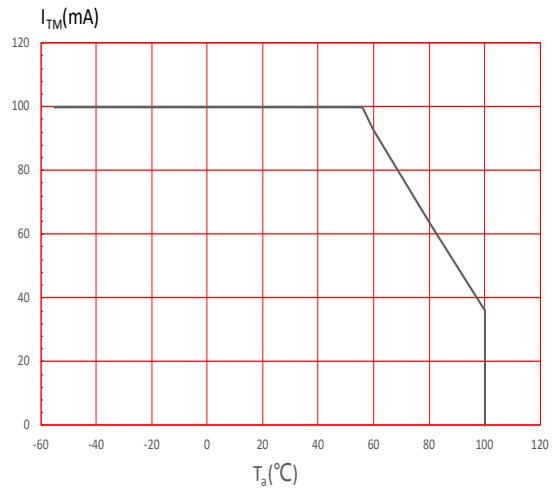

FIG.3: Forward Current vs. Forward Voltage

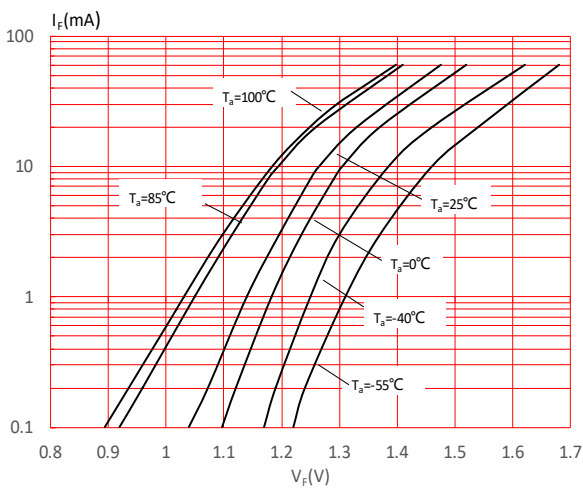

FIG.4: Normalized Off-state Terminal Current vs. Ambient Temperature

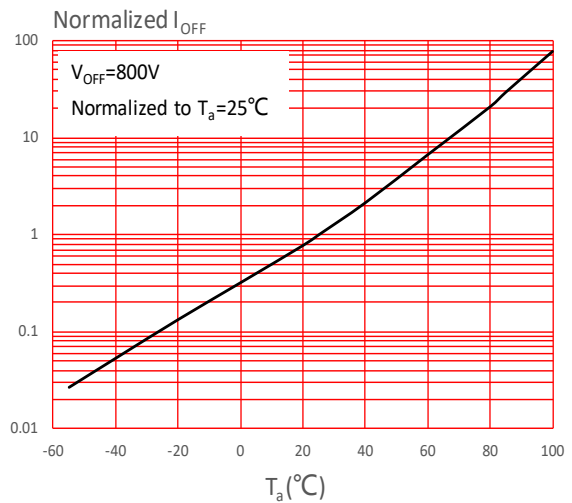

FIG.5: Normalized Off-state Terminal Voltage vs. Ambient Temperature

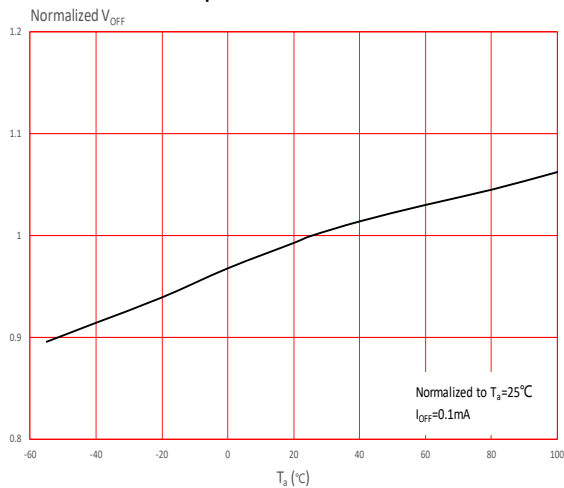

FIG.6: Normalized Trigger Current vs. Ambient Temperature

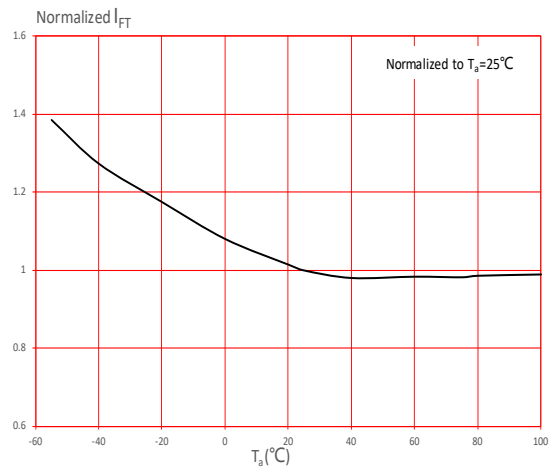

FIG.7: Normalized On-state Terminal Voltage vs. Ambient Temperature

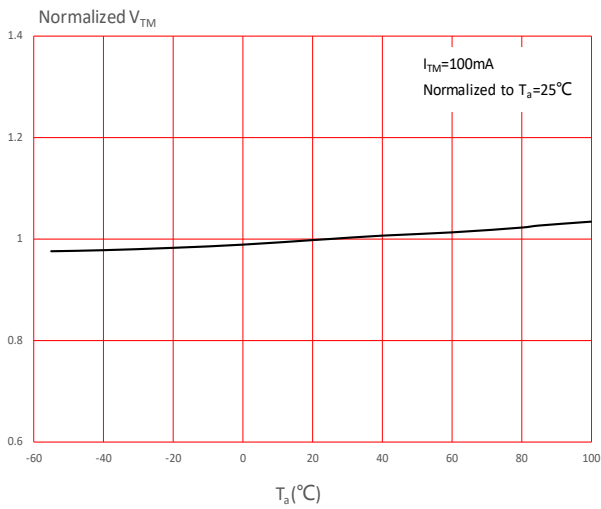

FIG.8: On-state Terminal Voltage vs. On-state Terminal Current

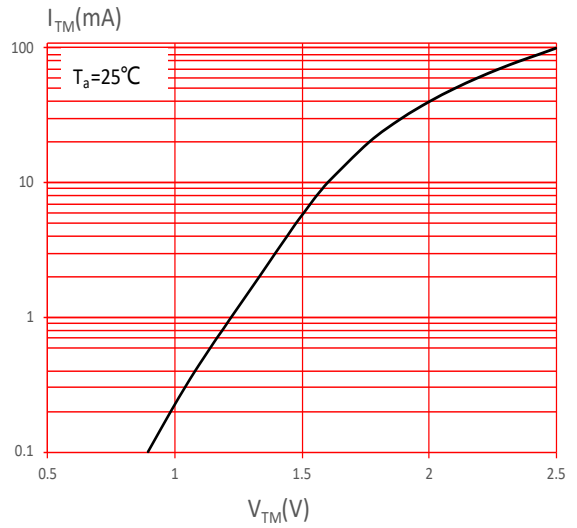

FIG.9: Normalized Holding Current vs. Ambient Temperature

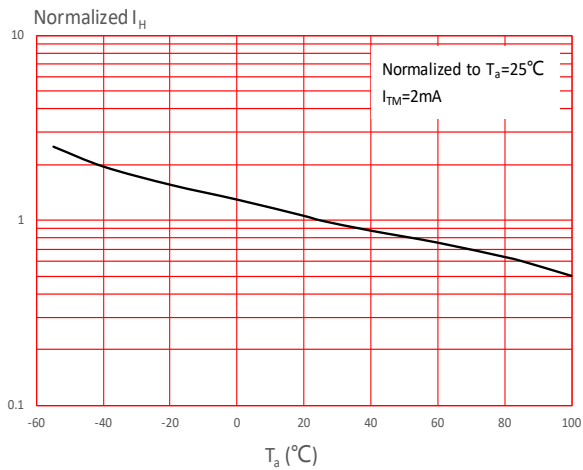

FIG.10: Turn On Time vs. Forward Current

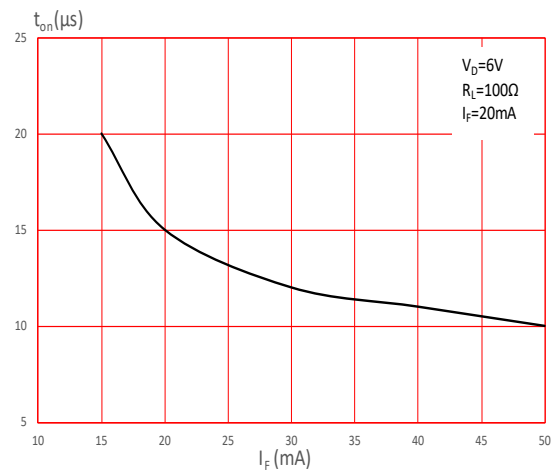
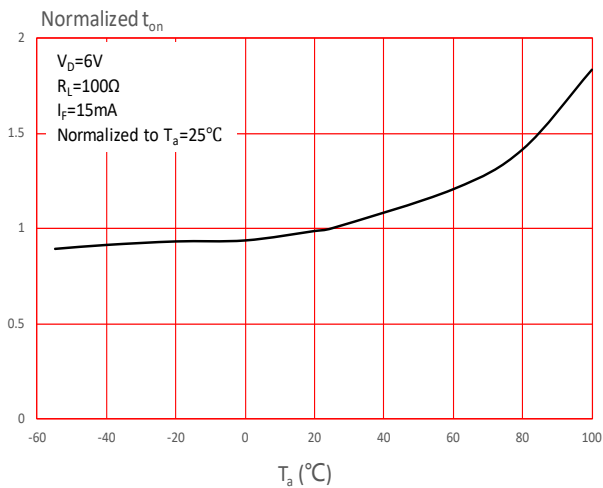

FIG.11: Normalized Turn On Time vs. Ambient Temperature



TEST CIRCUITS

FIG.12: Test Circuits of Turn On Time

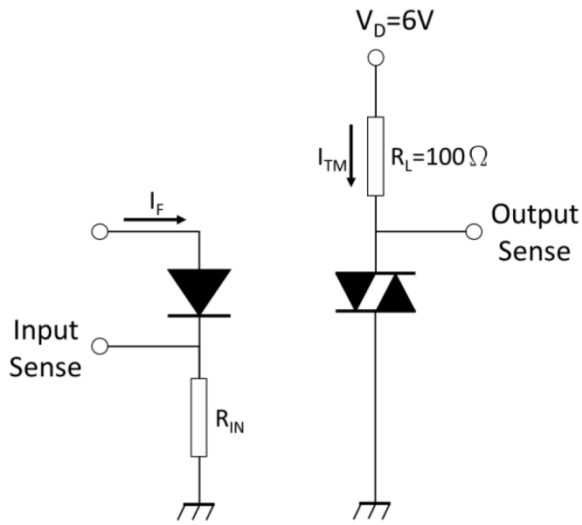

FIG.13: Waveforms of Turn On Time



Fig.14: Test Circuits of dV/dt



Fig.15: Waveforms of dV/dt

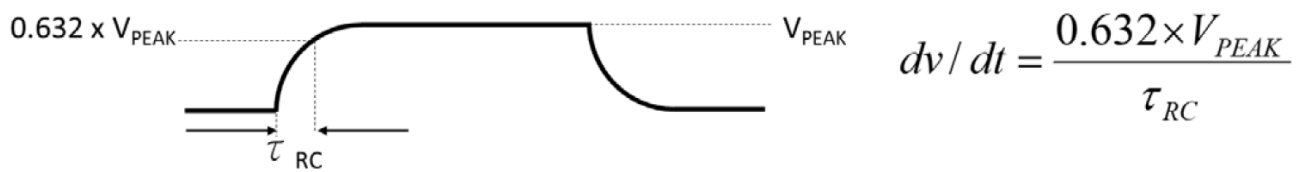

Package Dimension (Unit: mm)

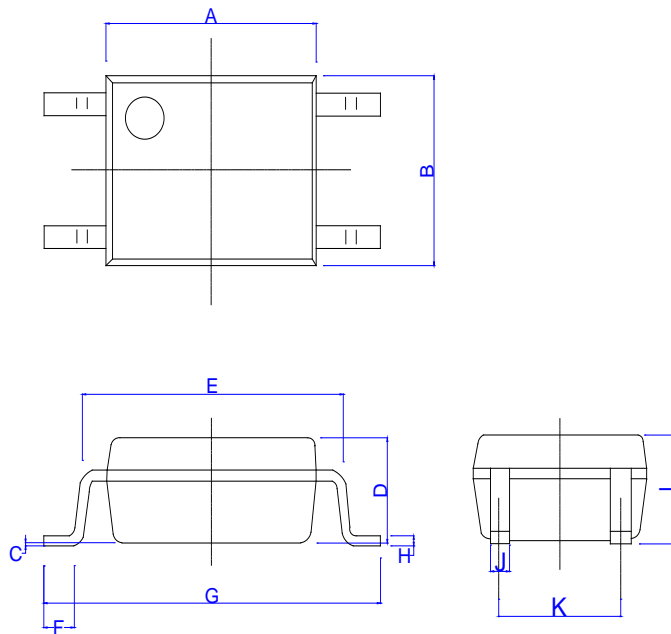

Ref.	Dimensions					
	Millimeters			Inches		
	Min.	Typ.	Max.	Min.	Typ.	Max.
A	4.20		4.85	0.165		0.191
B	3.30		4.40	0.130		0.173
C	0.00		0.20	0.000		0.008
D	1.75		2.80	0.069		0.110
E	4.90		5.80	0.193		0.228
F	0.30		0.90	0.012		0.035
G	6.30		7.30	0.248		0.287
H	0.10		0.30	0.004		0.012
I	1.80		2.90	0.071		0.114
J	0.25		0.55	0.010		0.022
K	2.29		2.79	0.090		0.110

RECOMMENDED SOLDER MASK (Dimensions in mm unless otherwise stated)

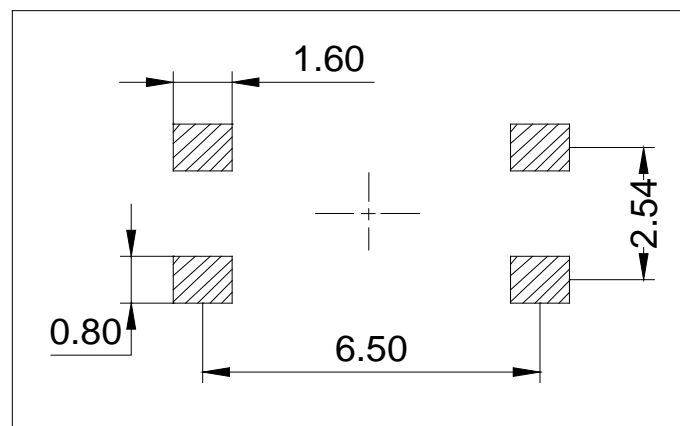

CARRIER TAPE SPECIFICATIONS (Dimensions in mm unless otherwise stated)

Option T1

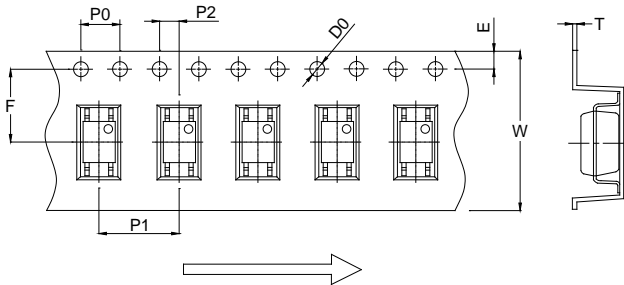

Ref.	Dimensions					
	Millimeters			Inches		
	Min.	Typ.	Max.	Min.	Typ.	Max.
D0		1.45	1.65		0.057	0.065
P0	3.90	4.00	4.10	0.154	0.157	0.161
P1	7.90	8.00	8.10	0.311	0.315	0.319
P2	1.90	2.00	2.10	0.075	0.079	0.083
E	1.65	1.75	1.85	0.065	0.069	0.073
F	7.40	7.50	7.60	0.291	0.295	0.299
T	0.15	0.30	0.45	0.006	0.012	0.018
W	15.70	16.00	16.30	0.618	0.630	0.642

Option T2

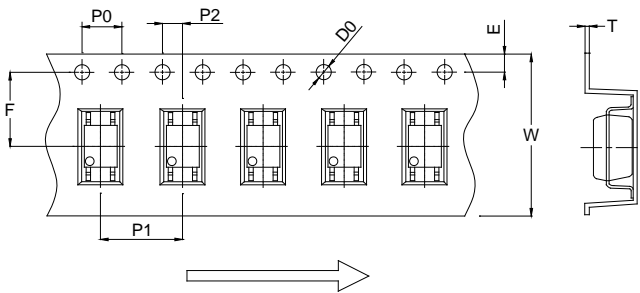

Ref.	Dimensions					
	Millimeters			Inches		
	Min.	Typ.	Max.	Min.	Typ.	Max.
D0		1.45	1.65		0.057	0.065
P0	3.90	4.00	4.10	0.154	0.157	0.161
P1	7.90	8.00	8.10	0.311	0.315	0.319
P2	1.90	2.00	2.10	0.075	0.079	0.083
E	1.65	1.75	1.85	0.065	0.069	0.073
F	7.40	7.50	7.60	0.291	0.295	0.299
T	0.15	0.30	0.45	0.006	0.012	0.018
W	15.70	16.00	16.30	0.618	0.630	0.642

REFLOW INFORMATION

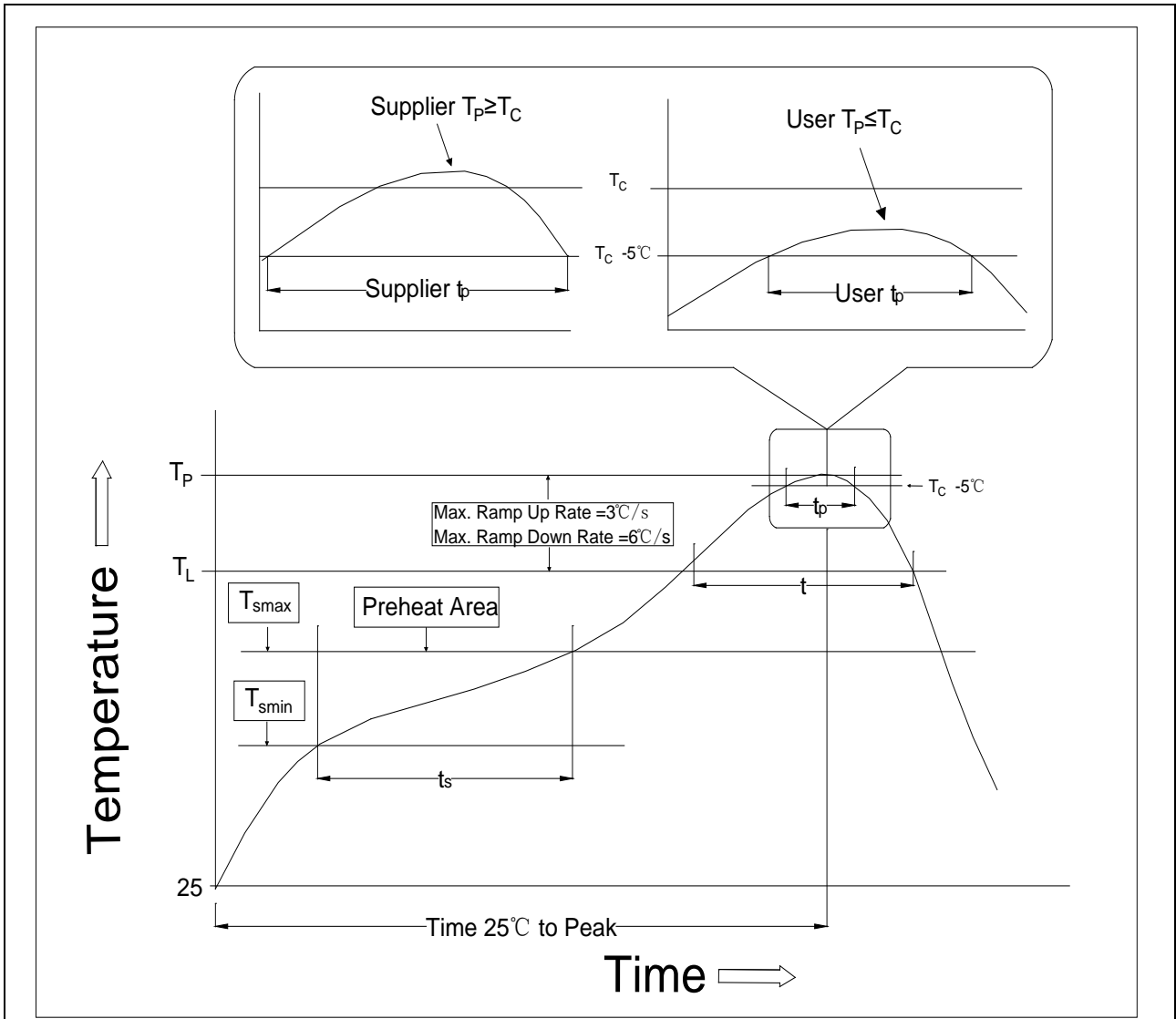

Profile Feature	Sn-Pb Assembly Profile	Pb-Free Assembly Profile
Temperature Min. (T _{smin})	100	150°C
Temperature Max. (T _{smax})	150	200°C
Time (t _s) from (T _{smin} to T _{smax})	60-120 seconds	60-120 seconds
Ramp-up Rate (t _L to t _P)	3°C/second max.	3°C/second max.
Liquidus Temperature (T _L)	183°C	217°C
Time (t _L) Maintained Above (T _L)	60-150 seconds	60-150 seconds
Peak Body Package Temperature	235°C+0°C/-5°C	260°C+0°C/-5°C
Time (t _P) within 5°C of 260°C	20 seconds	30 seconds
Ramp-down Rate (T _P to T _L)	6°C/second max.	6°C/second max.
Time 25°C to Peak Temperature	6 minutes max.	8 minutes max.

Information furnished in this document is believed to be accurate and reliable. However, Jiangsu JieJie Microelectronics Co., Ltd. assumes no responsibility for the consequences of use without consideration for such information nor use beyond it. Information mentioned in this document is subject to change without notice, apart from that when an agreement is signed, Jiangsu JieJie complies with the agreement.

Products and information provided in this document have no infringement of patents. Jiangsu JieJie assumes no responsibility for any infringement of other rights of third parties which may result from the use of such products and information. This document supersedes and replaces all information previously supplied.



is a registered trademark of Jiangsu JieJie Microelectronics Co., Ltd.

Copyright © 2025 Jiangsu JieJie Microelectronics Co., Ltd. All rights reserved.